



iBook

iBook/iBook Special Edition





Basics

iBook/iBook Special Edition



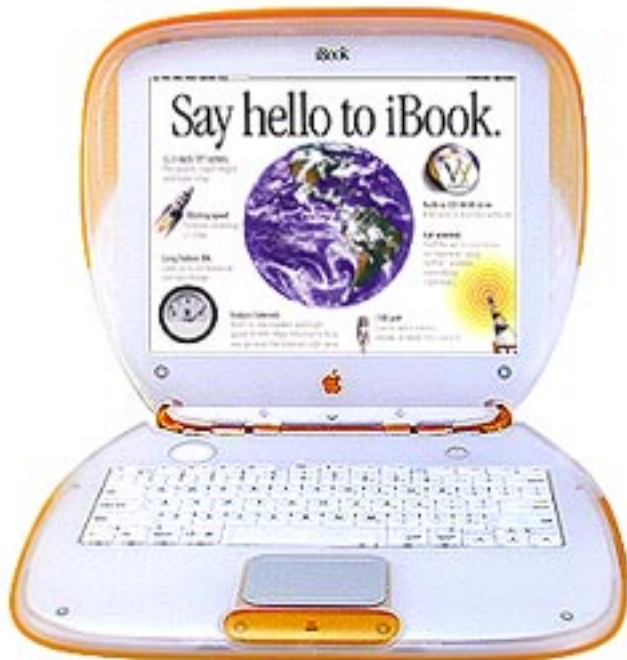

Overview

Product Overview

The iBook is designed for computing on the move. It features a tough, polycarbonate body, built-in handle, lithium-ion battery that runs up to six hours between charges, and support for AirPort wireless networking.

The iBook is based on the PowerPC G3 microprocessor and features





a 12.1-inch TFT display.

The iBook Special Edition was introduced in February, 2000 and features an increased processor speed of 366 MHz, a 6 GB hard drive, and 64 MB of RAM.





Service Strategy

The iBook is serviced exclusively through repair depots worldwide throughout the life of the product. Carry-in service to an Apple-authorized service provider is not available.

Important: Taking the computer apart beyond upgrading RAM or adding an AirPort Card may void the customer's warranty.

For more information about Apple's service strategy for iBook, refer to Program News on Service Source Online and the Service Source CD.





Warranty/AppleCare Protection Plan

The iBook is covered under the Apple One-Year Limited Warranty. The AppleCare Protection Plan is also available for this product. Refer to the Service Price Pages for repair facilitation reimbursement rates.





New Technologies

System Software—NewWorld ROM

The iBook is the second Macintosh portable to take advantage of ROM-in-RAM architecture. This design features a small ROM that provides hardware initialization functions and provides a mechanism to load the Mac OS ROM image into RAM. The new software architecture that is centered around ROM-in-RAM and its ramifications is named NewWorld.

ROM-in-RAM

Hardware-specific code resides in firmware (ROM) that fits into one ROM called the boot ROM. The boot ROM includes the code and tables needed to start up the computer, load an operating system, and provide common hardware access





services.

All higher-level software resides in what has been historically known as the Mac OS ROM, but with much of the old hardware-specific code moved into the boot ROM. As before, the Mac OS ROM can still be augmented by enablers, the System file, and extensions.

Prior to the iMac, all Macintosh computers required a ROM component that contained many components of the Mac OS software. The NewWorld approach sidesteps this requirement by copying an image of the Mac OS ROM into RAM before the Mac OS begins operation. Once the Mac OS begins operation, a Mac OS ROM image in RAM and an actual Mac OS ROM behave in the same way. No new or different software interfaces are directly accessible from the Mac OS.

During the boot process, software contained in the Mac OS ROM file communicates with Open Firmware to collect





information about the hardware, using the Open Firmware Client Interface.

RAM Footprint

Because the Mac OS ROM image is stored in RAM, approximately 3 MB of RAM is available for other uses. In effect, a system with 64 MB of RAM appears to have only 61 MB available. Some portion of the missing 3 MB is offset by having fewer patches in RAM.

Data Structures and Files

The Mac OS ROM image is contained in a new file, named Mac OS ROM, that resides in the System Folder. The Mac OS ROM image is exactly the same as it would be if it were an actual Mac OS ROM, containing the high-level software, the kernel software, and the 68K emulator.





Startup Disk Control Panel

Previous systems stored the user's selected startup device in Parameter RAM (PRAM) when the user selected a device in the Startup Disk control panel. The startup disk routine for the iBook, rather than setting Mac OS PRAM, sets an Open Firmware config variable called boot-device. Open Firmware honors this setting unless the selected device is unavailable or is overridden by the user.

The following keys can be pressed to override the selected startup device:

- Command-Option-Shift-Delete: ignore the boot-device setting and scan for alternate devices.
- C: force the internal CD-ROM drive to be the startup device.
- D: force the internal hard drive to be the startup device.





Features

Feature List

The features of iBook include:

- PowerPC G3 microprocessor running at a clock speed of 300, 333, or 366 MHz (iBook Special Edition)
- backside L2 cache of 512K
- 32 or 64 MB of SDRAM on the logic board and one expansion slot for up to 320 MB of SDRAM
- 3.2 or 6 GB built-in hard drive
- 12.1-inch TFT display with SVGA resolution (800 x 600 pixels)
- built-in CD-ROM drive
- 4MB of SDRAM video memory
- built-in 2D and 3D graphics acceleration via the ATI RAGE Mobility video controller





- lithium-ion battery with up to six hours of battery life
- one USB port for external keyboard, mouse, and other USB devices
- built-in Ethernet port with RJ-45 connector for 10BaseT and 100Base-TX operation
- built-in V.90 modem with 56 Kbps data rate
- built-in mono speaker and 16-bit stereo output jack
- keyboard with embedded numeric keypad and programmable function keys
- trackpad with tap/double tap and drag features
- optional wireless LAN via the AirPort Card





Drives

Hard Disks and HFS Plus

The iBook hard drives use Mac OS Extended format (HFS Plus). Some disk utility and disk locking programs manufactured by companies other than Apple are incompatible with HFS Plus.

Using an incompatible disk utility or disk locking program could result in hard drive corruption and loss of all data on the hard disk. Check the documentation that came with the program or contact the manufacturer or the vendor of the program before attempting to use it. Apple recommends using the utility Disk First Aid, which is included on the system software CD that ships with the iBook.





Norton Utilities

⚠ Warning: Norton Utilities for Macintosh, v3.5.2 and 3.5.3 will not run on any of the iBook computers. Running versions 3.5.1 and below may cause hard drive corruption and loss of all data on the hard drive. See the Symantec Web site at <http://www.stfsupport@smithmicro.com> for more information on Norton Utilities and Mac OS Extended format.





Memory and Power

Sleep Memory Extension 1.0

Apple has identified a very rare issue that may occur when putting an iBook to sleep. The computer may be unable to recognize the hard drive at startup. To prevent this from happening, Apple strongly recommends that all iBook customers running systems prior to Mac OS 9.0.4 install the Sleep Memory Extension 1.0.

After installing the Sleep Memory Extension and restarting the iBook, the "Preserve memory contents on sleep" checkbox in the Energy Saver control panel will be dimmed and unavailable.

Download the Sleep Memory Extension 1.0 from the Apple Software Updates Web site at <http://www.apple.com/swupdates/>.





Battery

The iBook has one lithium-ion (Lilon) battery that will provide up to six hours of battery life when all power saving features are implemented. With the power adapter plugged in, the iBook battery recharges in four hours while the computer is running, or in two hours when the computer is shut down or in sleep mode.

The iBook battery is not compatible with any previous Macintosh portable computer.

No Backup Battery

The iBook has no backup battery. You will lose all data stored in RAM if you change the battery while the system is in sleep mode and no power adapter is connected. Therefore, shut the system down before changing the battery, or make sure a power adapter is connected.





Battery Handling Guidelines

⚠ Warning: Lithium-ion (Lilon) batteries contain hazardous chemicals and should not be thrown out with household or office trash. Review battery handling and disposal instructions in Safety Information in Bulletins/ Safety.

The following are guidelines for properly handling batteries:

- Handle the battery carefully. Do not drop, puncture, disassemble, mutilate, or incinerate it.
- Do not leave a battery in the computer for longer than a week without plugging in the power adapter.
- Do not short the battery contacts.
- Do not leave the battery in hot locations (such as the trunk of a car).
- Do not leave a battery in storage for longer than six





- months without recharging it.
- Never get batteries wet.
 - Recharge batteries only as described in the user's manual and only in ventilated areas.

Battery Verification

When the power adapter is being used, the ring around the power adapter port glows green when the battery is fully charged. The ring glows amber if the battery is being charged.

You can also check the battery status by looking at the Battery portion of the control strip or the battery symbol in the upper right corner of the Finder menu bar.





Power Adapter Verification

Try using a known-good power adapter if the computer cannot run off the existing one, or try the existing power adapter with another iBook or G3 Series PowerBook

Under normal operation, the ring around the power adapter port will glow green or amber if the computer is receiving adequate power. If the computer is not receiving adequate power, the ring will not glow green or amber.





Sound and Video

Sound Out

The iBook has one mono speaker located on the bottom case. A headphone jack located on the left side of the computer supports stereo headphones or external powered speakers. When headphones or speakers are plugged into the external jack, the sound to the internal speaker is turned off.

The iBook has no microphone or sound-input jack.





Input/Output

USB

The iBook has one Universal Serial Bus (USB) port that can be used to connect I/O devices such as a USB mouse, printers, scanners, and low-speed storage devices. The ports use USB Type A connectors, which have four pins.

The iBook does not support the power-on key on the Apple USB keyboard.

Ethernet

The iBook has a built-in 10/100 Mbps Ethernet port using a RJ-45 connector. When connected to either a 10Base-T or a 100Base-TX hub, the port will recognize which type of hub is connected.





Keyboard

The iBook keyboard includes an embedded numeric keypad and controls to adjust display brightness, speaker volume, and the Num Lock function.

Several of the keys on the keyboard have more than one mode of operation. These changes are controlled by the Num Lock key, Fn key, and the Function Keys checkbox in the Keyboard control panel.

Num Lock Key

Press the Num Lock key to:

- Select the embedded numeric keypad on the right portion of the alphanumeric keys.
- Make the rest of the alphanumeric keys functionless.





Fn Key

Press the Fn key to:

- Toggle the function keys between their normal control functions and their alternate F1–F12 functions.
- Select the embedded numeric keypad on the right portion of the alphanumeric keys.
- Change certain control keys, including the cursor control keys, to page control keys.

Table 1 below shows the operations controlled by function keys when the Fn key is pressed.

Key	Operation
F1	Decrease display brightness
F2	Increase display brightness
F3	Decrease speaker volume





Key	Operation
F4	Increase speaker volume
F5	Num Lock
F6	Mute speaker

Table 1: Function Key Operation

Function Keys Checkbox

The Fn key lets the user switch the mode of operation of the function keys. The user selects the default mode of the function keys in the Function-keys checkbox in the Keyboard Control Panel. The Function-keys checkbox lets the user choose whether the function key operations are primary or secondary.

Function keys primary means the function keys are





normally in their F1–F12 mode of operation. Pressing the Fn key activates their control-button mode.

Function keys secondary means the function keys are normally in their control-button mode and pressing the Fn key activates their function-key mode.





Boards and Cards

The architecture of the iBook is designed around one logic board that contains the microprocessor and two new custom ICs. Besides the logic board, the iBook can contain up to five boards and cards: charging board, DC-in board, RAM card, modem, inverter board, and AirPort Card.

AirPort Card

The iBook supports the AirPort Card, an internal wireless LAN module. The AirPort Card is available as a build-to-order option or as a user-installable upgrade through the Apple Store. The AirPort Card can be used for Internet access, e-mail access, and file exchange.

For more information, refer to the AirPort service manual on Service Source CD or Service Source Online.





Views

Front View

The front of the iBook includes the: power button, sleep indicator, reset button, volume and brightness controls, keyboard release tabs, keyboard lock, trackpad and trackpad button, and speaker.

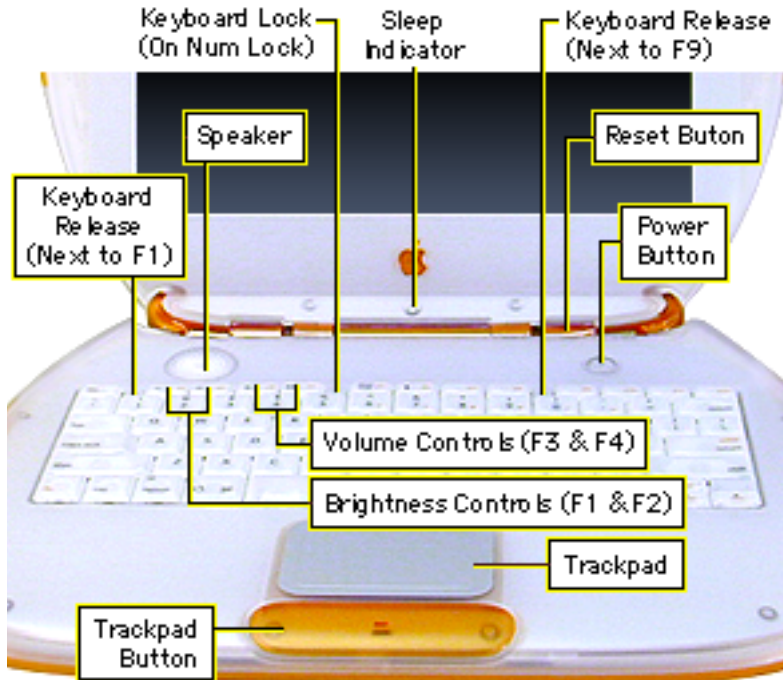



Right Side View

The right side of the iBook includes the: power adapter port, CD-ROM drive, and CD manual eject button.

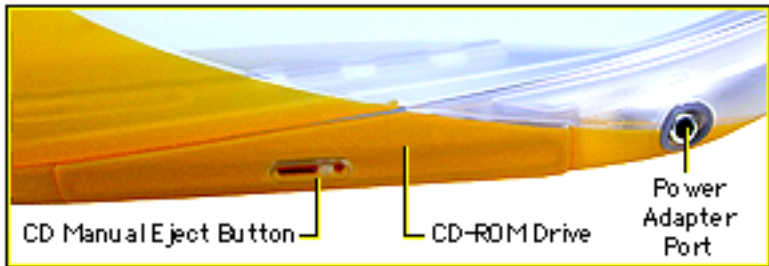



Left Side View

The left side of the iBook includes the following ports: sound out, USB, Ethernet, and internal modem.

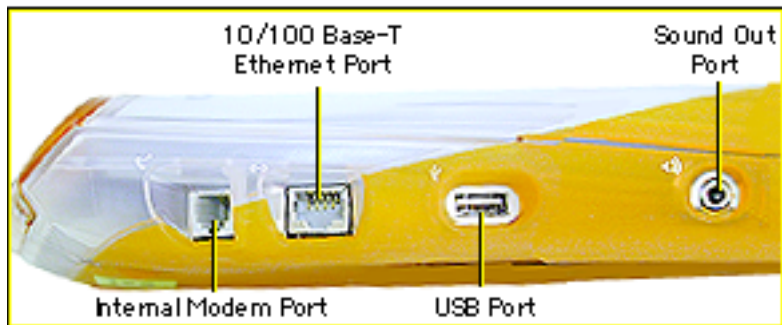



Back View

The handle of the iBook is on the back side.





Bottom View

The bottom of the iBook includes the battery door with spring-loaded screws, and the contacts for a third-party charging station.

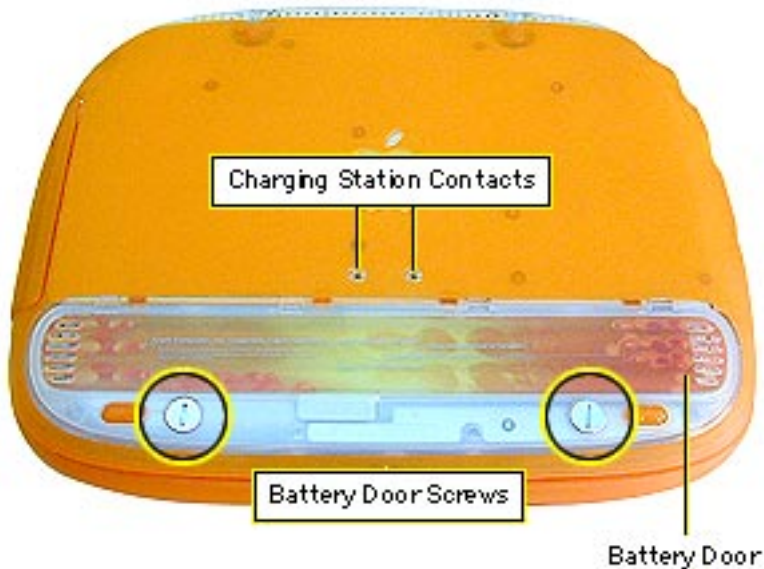



Logic Board

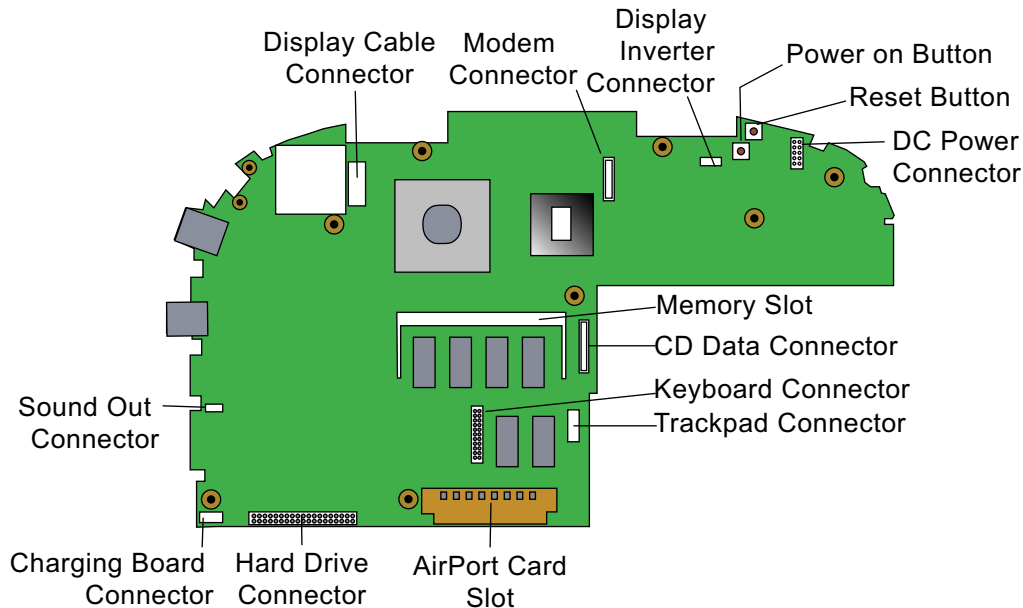

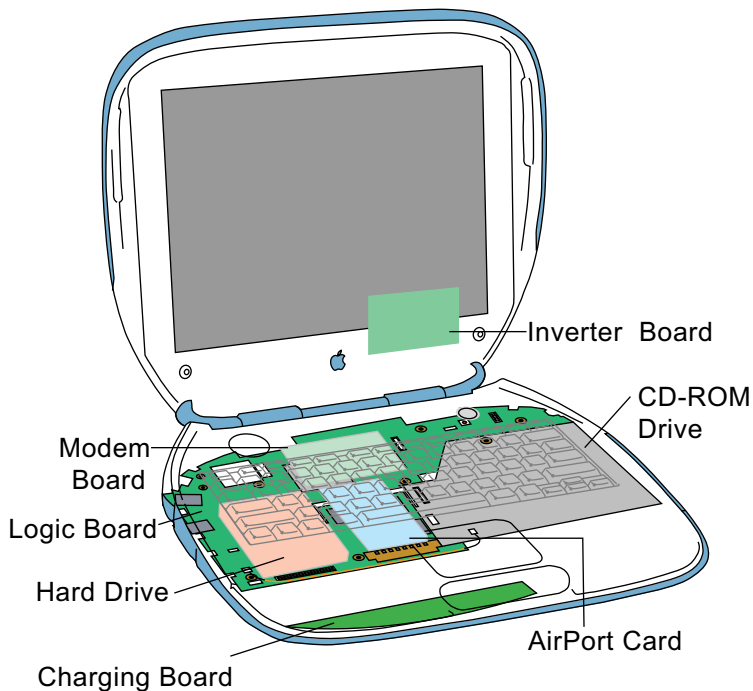

Internal Hardware Locator

The upgradeable RAM slot is located under the AirPort Card and RAM access door. To reach the CD-ROM drive and modem, remove the keyboard and top case.

Remove the logic board EMI shield to access the remaining components, including the hard drive.





Specifications

iBook/iBook Special Edition





Introduction

Specifications information for this product can be found in the Spec Database, which you can access at Service Source Online (<http://service.info.apple.com>) or on Service Source CD.

Spec Database at Service Source Online

From the Service Source Online home page, click Troubleshoot and Repair to access the main repair procedures page. Then click either Apple Spec in the navigation table in the upper right corner of the page, or click Apple Spec Database from the list of reference tools below.

Spec Database on Service Source CD

Open the CD and double-click the Apple Spec Database alias located at the top level of the CD.





Troubleshooting

iBook/iBook Special Edition





General

How to Use the Symptom Charts

The Symptom Charts included in this chapter will help you diagnose specific symptoms related to the product. Because cures are listed on the charts in the order of most likely solution, try the cures in the order presented. Verify whether or not the product continues to exhibit the symptom. If the symptom persists, try the next cure. **Note:** If you have replaced a module, reinstall the original module before you proceed to the next cure.

For additional assistance, contact Apple Technical Support.





Power-On Self Test

A power-on self test resides in the ROM of the iBook. This test automatically runs whenever the computer is turned on after being fully shut down (the power-on self test does not run if the computer is only restarted). If a problem is detected during the test, you will not hear a normal startup chime. Instead, the system will give a series of beeps.

One beep: No RAM is detected.

Two beeps: EDO memory is installed. The iBook ships with SDRAM SO-DIMMs and does not accept EDO memory.

Three beeps: No RAM banks passed memory testing.

Four beeps: Bad checksum for the remainder of the boot ROM. The ROM (which is located on the microprocessor module) is bad.





Power Issues

⚠ Warning: The iBook has no backup battery. Therefore, shut the system down before changing the battery, or make sure an AC power adapter is connected. Changing the battery while the system is in sleep mode, without a power adapter, will result in a loss of all data stored in RAM.

Sleep

There is an option in the Energy Saver control panel called "Preserve memory contents on sleep." When this option is selected, the system creates a file containing all the information contained in RAM at that time, and stores it on the hard disk before going into sleep mode.





Battery Verification

When the power adapter is being used, the ring around the power adapter port glows green when the battery is fully charged. The ring glows amber if the battery is being charged.

You can also check the battery status by looking at the Battery portion of the control strip or the battery symbol in the upper right corner of the Finder menu bar.

Power Adapter Verification

Try using a known-good power adapter if the computer cannot run off the existing one, or try the existing power adapter with another iBook or G3 Series PowerBook.

Under normal operation, the ring around the power adapter port will glow green or amber if the computer is receiving adequate power.





Power Manager Reset

iBook computers have a reset button on the keyboard above the power button. Press the button once with a paper clip to reset the power manager. Make sure the button clears the plastic of the top case when you release it, and is not stuck in the down position.

PRAM Reset

⚠ Warning: Resetting PRAM erases the contents of the RAM disk if you do not have “Save on Shutdown” selected in the Memory control panel. Resetting PRAM also restores default settings in some control panels, so check custom settings after you reset PRAM.

- Turn on the computer by pressing the power button.
- Immediately hold the Option-Command-P-R keys.
- Hold down the keys until you hear the startup chime at least one additional time after the initial startup chime.





Block Diagram

This is a simplified block diagram of the iBook. The diagram shows the main ICs and the buses that connect them.

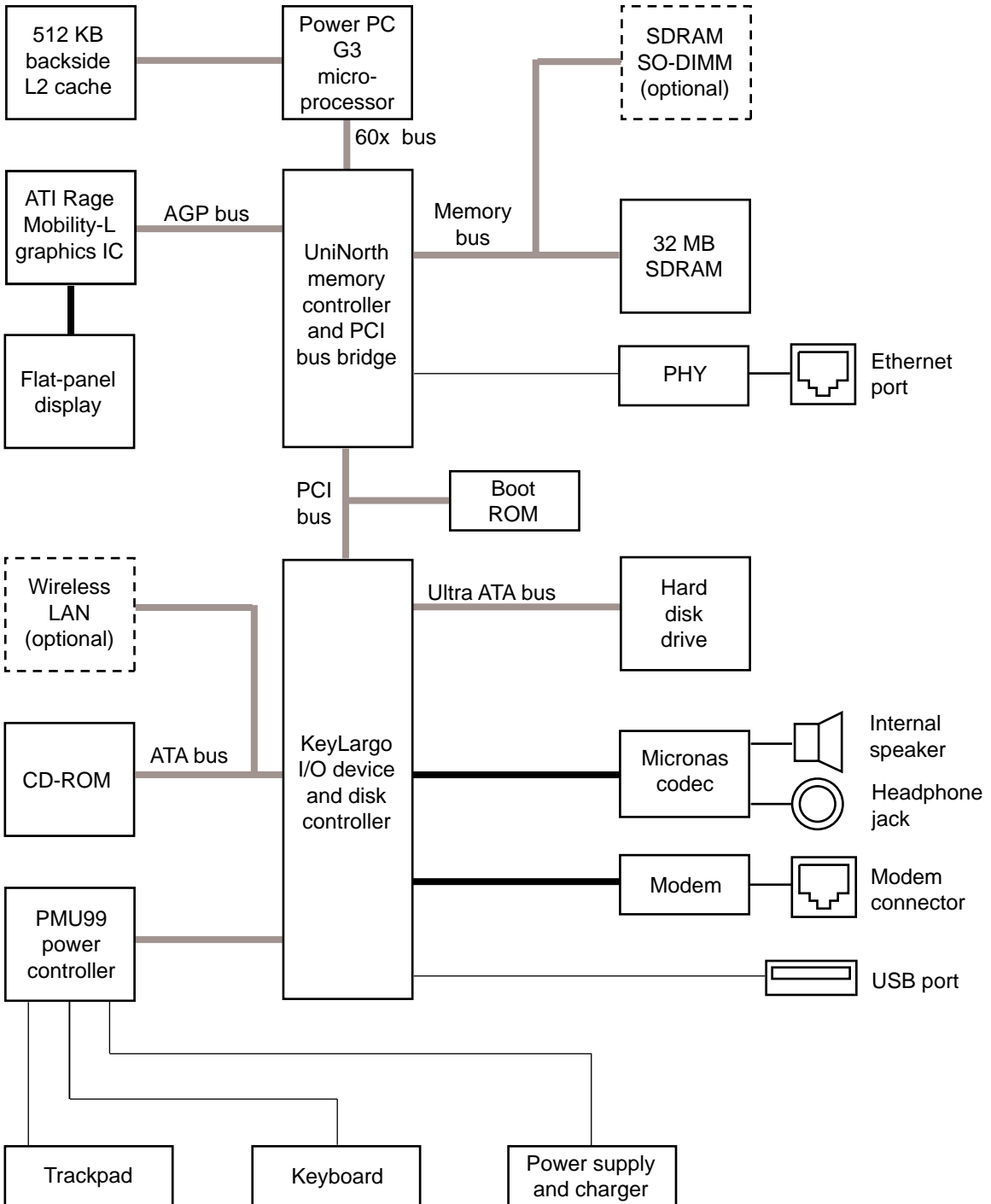



Symptom Charts

Startup

Beeps are heard at startup (one to four beeps)

- 1 One beep: No RAM is detected.
- 2 Two beeps: EDO memory is installed. The iBook ships with SDRAM SO-DIMMs and does not accept EDO memory.
- 3 Three beeps: No RAM banks passed memory testing.
- 4 Four beeps: Bad checksum for the remainder of the boot ROM. The ROM (which is located on the microprocessor module) is bad.

Dialog box “Built-in memory test has detected an error” comes up on startup

- 1 Remove RAM and test again.
- 2 Replace RAM card.
- 3 Contact Apple to schedule repair.





Power

Computer won't start up

- 1 Reset the power manager by pressing the reset button above the power button. Wait five seconds and press the power button. **Note:** Before continuing, make sure the reset button is not caught under the plastic of the top case.
- 2 Try known-good power adapter.
- 3 Remove battery.
- 4 Disconnect internal keyboard completely and try starting up unit. If unit starts up, contact Apple to schedule repair.
- 5 Remove any additional RAM and AirPort Card.
- 6 Contact Apple to schedule repair.





Computer runs when plugged into wall outlet but not on battery power

- 1 Turn off the computer, then Reset the power manager by pressing the reset button above the power button. Wait five seconds and press the power button. **Note:** Before continuing, make sure the reset button is not caught under the plastic of the top case.
- 2 Reseat battery to make sure battery is mating with contacts on logic board.
- 3 Try known-good, firmly seated, charged battery. Repeat once.
- 4 Contact Apple to schedule repair.

Computer runs with battery, but not with the power adapter plugged into wall outlet

- 1 Reset the power manager by pressing the reset button above the power button. Wait five seconds and press the power button. **Note:** Before continuing, make sure the reset button is not caught under the plastic of the top case.
- 2 Try a known-good power adapter.
- 3 Check lights around power port to see if they glow amber or green.
- 4 Contact Apple to schedule repair.





Screen is blank;
backlight isn't on;
computer doesn't
respond

- 1 Reset the computer by holding Command-Control-power button simultaneously.
- 2 Reset the power manager by pressing the reset button above the power button. Wait five seconds and press the power button. **Note:** Before continuing, make sure the reset button is not caught under the plastic of the top case.
- 3 Check power adapter cable.
- 4 Try known-good, charged battery.
- 5 Try known-good power adapter.
- 6 Reset PRAM. Press the power button, then hold down the Option-Command-P-R keys until you hear the startup chime at least one additional time after the initial startup chime.
- 7 Remove keyboard and additional memory (if installed) and restart computer.
- 8 Contact Apple to schedule repair.





Power adapter is plugged in, but Control Strip doesn't indicate adapter is connected

- 1 Verify that power adapter is connected correctly and the power cord is plugged solidly in the adapter.
- 2 Verify that there is power at the outlet.
- 3 Try known-good power adapter (45 watt).
- 4 Try known-good power cord.
- 5 Reset the power manager by pressing the reset button above the power button. Wait five seconds and press the power button. **Note:** Before continuing, make sure the reset button is not caught under the plastic of the top case.
- 6 Contact Apple to schedule repair.

Battery won't charge

- 1 Turn off the computer and press the reset button above the power button. Wait five seconds and press the power button.
- 2 Insert battery, leave in 15 seconds, then remove it. Repeat 4-5 times.
- 3 Try known-good battery. Repeat once.
- 4 Contact Apple to schedule repair.





Battery will not charge unless unit is in sleep mode or shut down

Verify that the appropriate power adapter (45 watt) is being used.





Video

Note: A certain number of pixel anomalies are inherent in liquid crystal display technology and vary by many factors, including type of technology. If you suspect that the display contains an abnormal number of pixel anomalies, call Apple Technical Support.

Partial or full row of pixels is always on or never comes on

Contact Apple to schedule repair.

Multiple vertical or horizontal rows of pixels are always on or never come on

Contact Apple to schedule repair.





No display, but computer appears to operate correctly

- 1 Connect power adapter.
- 2 Adjust screen brightness setting with Fn key pressed and not pressed.
- 3 Restart computer by holding Command-Control-power button.
- 4 Reset the power manager by pressing the reset button above the power button. Wait five seconds and press the power button. **Note:** Before continuing, make sure the reset button is not caught under the plastic of the top case.
- 5 Contact Apple to schedule repair.

Backlight doesn't operate; screen is very dim

- 1 Adjust screen brightness setting.
- 2 Contact Apple to schedule repair.





Display is very light
or totally white

- 1 Start up from CD to verify the problem is not software.
- 2 Verify display cable and inverter board cable connections to the logic board.
- 3 Contact Apple to schedule repair.





Sound

No sound from speaker

- 1 Verify that mute mode is not enabled (F6 on the keyboard).
- 2 Check the volume setting by pressing F4 on the keyboard without pressing the function key first.
- 3 Verify no external speakers or headphones are plugged in.
- 4 Reset PRAM. Press the power button, then hold down the Option-Command-P-R keys until you hear the startup chime at least one additional time after the initial startup chime.
- 5 Contact Apple to schedule repair.

Startup sound is heard, then no sound from speaker

- 1 Remove sound preferences from System Folder, reset PRAM, then restart.
- 2 Perform clean installation of system software.





Volume control does not operate correctly

- 1 Check the Fn keys with the Fn key down.
- 2 Check Monitors & Sound control panel setting.
- 3 Verify that mute mode is not enabled.
- 4 Verify the setting of volume control button.
- 5 Verify hot keys are enabled in the Keyboard control panel.
- 6 Reset the power manager by pressing the reset button above the power button. Wait five seconds and press the power button. **Note:** Before continuing, make sure the reset button is not caught under the plastic of the top case.
- 7 Verify software by booting from the CD.
- 8 Contact Apple to schedule repair.





Hard Drive

Internal hard drive
does not spin

- 1 Make sure power adapter is connected.
- 2 Disconnect external USB devices.
- 3 Verify Drive Setup does not see the hard drive.
- 4 Check hard drive connection.
- 5 Contact Apple to schedule repair.





CD-ROM Drive

Drive does not accept disc (mechanical failure)

- 1 Verify disc is properly seated in the carrier.
- 2 Contact Apple to schedule repair.

Disc icon does not show up on desktop, or dialog box appears to initialize disc

- 1 Verify disc is not a DVD-ROM or DVD-RAM disc.
- 2 Check that the correct software extensions are loaded.
- 3 Replace disc (if dirty or damaged).
- 4 Contact Apple to schedule repair.





Modem

No dial tone

- 1 Verify known-good analog (not digital) telephone line.
- 2 Verify cable is not plugged into Ethernet port.
- 3 Verify cable is firmly installed in the modem port.
- 4 If using Apple Remote Access 3.0, select Ignore Dial Tone in the Modem control panel. If the modem connects with this setting selected, try another phone line. If using a terminal or communications program, enter `atx1` to disable tone detection. To reset the modem back to the factory settings, enter `atz`.
- 5 Contact Apple to schedule repair.

No internal modem selection available

- 1 Verify correct modem software is installed and selected.
- 2 Reset PRAM and perform a clean installation of system software.
- 3 Contact Apple to schedule repair.





USB Peripherals

After you connect external USB device, computer does not start up

- 1 Verify current driver for the device is installed (check with the manufacturer of the device).
- 2 Disconnect all external devices and boot computer. Then plug in USB peripherals.
- 3 Eliminate chain by plugging in only one peripheral.
- 4 If USB device is self-powered, switch on external USB device before starting computer.
- 5 Check cable connections.
- 6 Try known-good USB cable.
- 7 Try known-good external USB device.
- 8 Contact Apple to schedule repair.





USB device not recognized by computer

Note: If you are trying to use a serial device with a USB/Serial adapter, check with the manufacturer of the adapter for compatibility.

- 1 Verify current driver for the device is installed.
- 2 Turn on camera after initiating download with camera application.
- 3 Try different USB device on same port.
- 4 Eliminate chain by plugging in only one peripheral.
- 5 Troubleshoot extensions and perform a clean installation of system software.
- 6 Contact Apple to schedule repair.





I/O devices are unrecognized, or garbage is transmitted or received

- 1 Check cables.
- 2 Check with vendor for current drivers.
- 3 Test device with known-good computer.
- 4 Troubleshoot extensions and perform a clean installation of system software.
- 5 Contact Apple to schedule repair.

Known-good USB printer does not print

- 1 Verify that computer has correct driver installed. Check vendor's Web site to download current driver.
- 2 Reset PRAM. Press the power button, then hold down the Option-Command-P-R keys until you hear the startup chime at least one additional time after the initial startup chime.
- 3 Verify that Chooser and Control Panel settings are correct.
- 4 Run Apple System Profiler to see if it recognizes that a USB printer is connected. If it does, it is a software issue.
- 5 Check cables.
- 6 Contact Apple to schedule repair.





USB device experiences a partial lack of power	1 2	1 Plug the device into an electrical outlet if it has a power cord. 2 Unplug the device and plug it into another device plugged into a power outlet such as a USB hub.
Not enough power for the USB device to function at all	1 2	1 Plug the device into an electrical outlet if it has a power cord. 2 Unplug the device and plug it into another device plugged into a power outlet such as a USB hub.
After sleep, a USB peripheral is sometimes not recognized	1 2	1 Restart the unit. 2 Contact peripheral manufacturer for latest driver update.





Keyboard and Trackpad

No response from any key on keyboard

- 1 Verify that computer is on.
- 2 Reset the power manager by pressing the reset button above the power button. Wait five seconds and press the power button. **Note:** Before continuing, make sure the reset button is not caught under the plastic of the top case.
- 3 Boot from the system software CD.
- 4 Check keyboard connection by disconnecting and reconnecting the keyboard cable.
- 5 Contact Apple to schedule repair.





Cursor does not move when you are using trackpad

- 1 Verify that no USB device is connected.
- 2 Reset power manager and boot from startup CD. (Reset the power manager by pressing the reset button above the power button. Wait five seconds and press the power button. **Note:** Before continuing, make sure the reset button is not caught under the plastic of the top case.)
- 3 Check trackpad connection to the logic board (remove RAM access door).
- 4 Contact Apple to schedule repair.





Cursor moves on screen with external mouse connected, but clicking or double-clicking the mouse has no effect

- 1 If the mouse is connected to an external USB keyboard, connect the mouse to the USB port on the computer.
- 2 Try an Apple mouse with no other USB devices connected.
- 3 Boot off the CD that came with the computer. If the mouse works, perform a clean installation of the system software.

Cursor moves, but clicking trackpad button has no effect

- 1 Reset the power manager by pressing the reset button above the power button. Wait five seconds and press the power button. **Note:** Before continuing, make sure the reset button is not caught under the plastic of the top case.
- 2 Contact Apple to schedule repair.





Cursor does not move on the screen with an external mouse, but USB external keyboard works

- 1 Verify that the mouse is connected securely to the USB keyboard or port.
- 2 Check inside mouse for buildup of dirt or other contaminants. Clean mouse if necessary.
- 3 Start up from the system software CD to see if the problem is software.
- 4 If mouse is connected to the keyboard, connect it to a USB port.
- 5 Try another mouse.
- 6 Contact Apple to schedule repair.





Cursor intermittently does not move or moves erratically

Note: User must touch trackpad with the surface of only one finger at a time and point directly down on the trackpad surface.

- 1 Clean trackpad surface (with computer off, using a non-static-inducing material).
- 2 Reset the power manager by pressing the reset button above the power button. Wait five seconds and press the power button. **Note:** Before continuing, make sure the reset button is not caught under the plastic of the top case.
- 3 Try unit on battery power. If problem goes away, replace power adapter.
- 4 Boot from the system software CD to see if the problem is software.
- 5 Check trackpad connection to the logic board (remove RAM access door).
- 6 Contact Apple to schedule repair.





Miscellaneous

iBook goes in and out of sleep mode with clamshell shut

- 1 Check keyboard to see if it is bowed from improper RAM or AirPort card installation. (Raised keys could make contact with top case, causing the computer to wake from sleep.)
- 2 Reseat AirPort Card.
- 3 Reseat RAM.
- 4 Contact Apple to schedule repair.

Sleep light won't come on

- 1 Verify that computer is in sleep mode and not turned off.
- 2 Reset the power manager by pressing the reset button above the power button. Wait five seconds and press the power button. **Note:** Before continuing, make sure the reset button is not caught under the plastic of the top case.
- 3 Contact Apple to schedule repair.





Screen goes blank and computer shuts down every few minutes

- 1 Computer is going into system sleep to conserve battery power. Adjust sleep delays in Energy Saver control panel or connect power adapter.
- 2 Verify that the appropriate power adapter is being used.
- 3 Try a known-good power adapter.

Application seems to run slower after a few seconds

Computer is either in processor cycling mode or in reduced processor speed mode. If this interferes with operation of application, turn off Allow Processor Cycling in the Energy Saver control panel and quit any other applications running in the background. **Note:** These features extend battery life when running off battery power.





Hard drive is slow to respond, or screen goes blank too often

Adjust sleep delays in Energy Saver control panel or connect power adapter.

Known-good Ethernet network printer does not print

- 1 Verify that Chooser and Control Panel settings are correct.
- 2 Reinstall printer drivers.
- 3 Check cables.
- 4 Attach computer directly to printer using Ethernet crossover cable, and retest.
- 5 Reset PRAM. Press the power button, then hold down the Option-Command-P-R keys until you hear the startup chime at least one additional time after the initial startup chime.
- 6 Contact Apple to schedule repair.

FAX software is not working

The iBook comes with FAXSTF software installed. Apple does not provide support for this software. Contact STF Technology (Smith Micro) at 660-463-2021 or at stfsupport@smithmicro.com.





iBook Startup Problems Flowchart

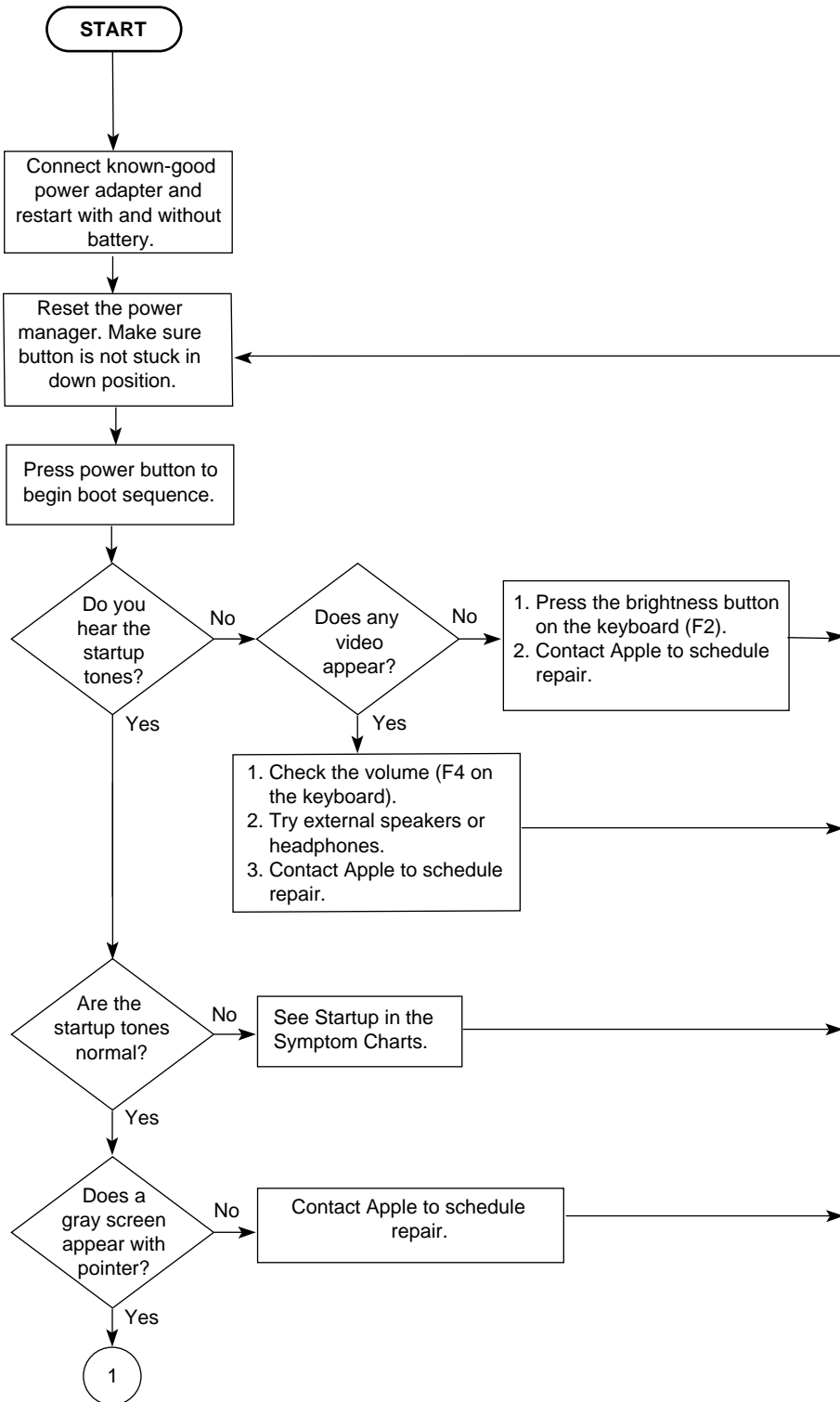



iBook Startup Problems Flowchart (cont.)

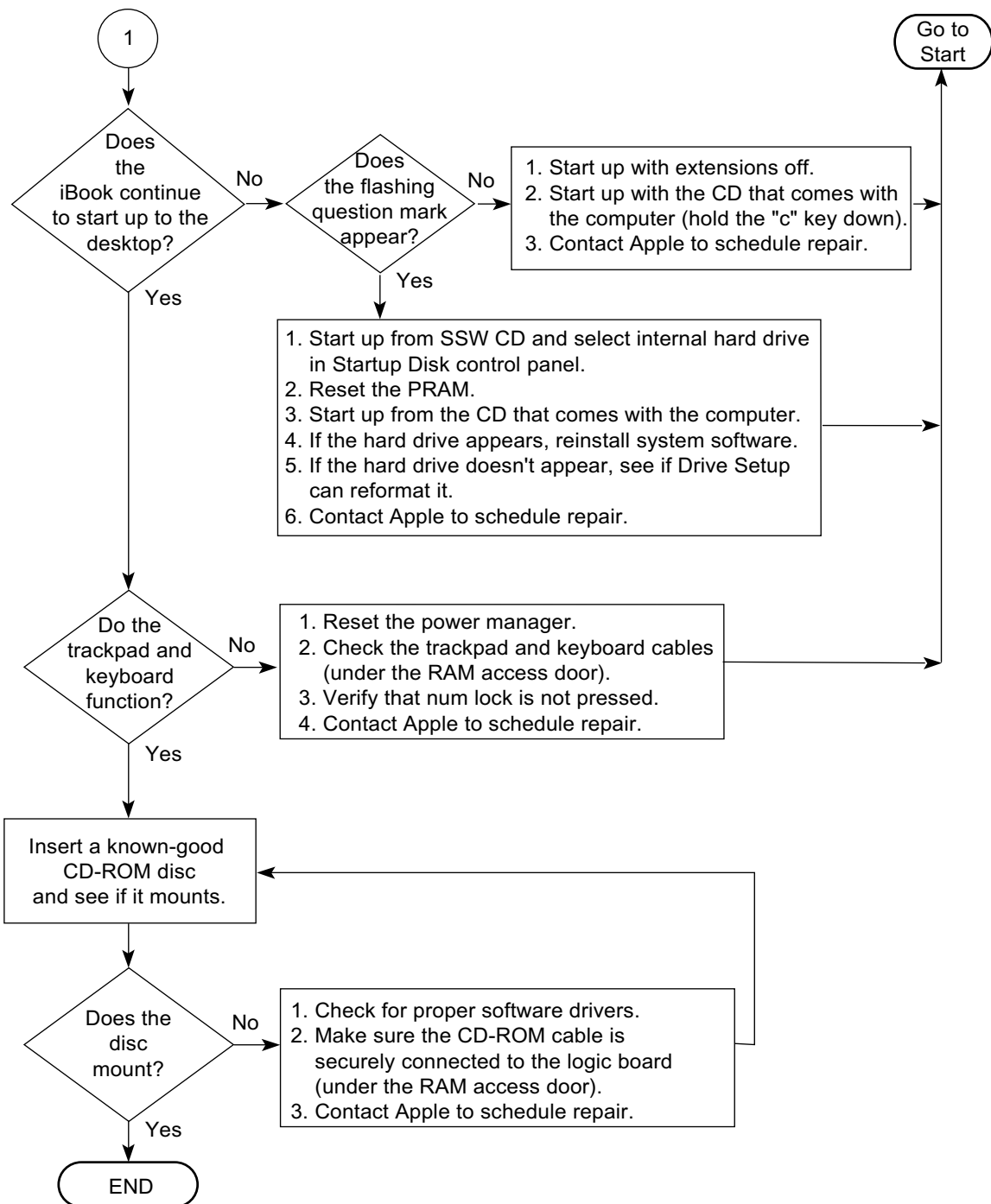



Take Apart

iBook/iBook Special Edition





Introduction

Take Apart procedures are not available for iBook. Refer to the Upgrades chapter of the iBook service manual for AirPort Card and RAM installation procedures.





Upgrades

iBook/iBook Special Edition





Overview

Customers may wish to upgrade iBook with additional RAM or an AirPort Card. Instructions for performing these upgrades are contained in the user's manual. A more detailed version is included in this chapter to help you if you are asked to do this for customers.

Important: Taking the computer apart beyond upgrading RAM or adding an AirPort Card may void the customer's warranty.





AirPort Card Installation

Before you begin, unplug the AC adapter.

1. Use a coin or key to turn the battery cover screws a quarter turn to the left. The screws will pop up but not come out all the way.
2. Remove the battery cover and pull the battery out of its compartment.





3. Turn the computer over, open it, and place a cloth over the palmrest to protect the surface.
4. If the keyboard is locked, turn the keyboard lock (located to the left of the num lock key) a half turn in either direction until the tab clears the plastic of the top case.





5. Press down on the two keyboard release tabs (located on the keyboard between the F1 and F9 keys), and slide them toward you.
6. When the keyboard pops up, move it away from you to release the tabs in the front.
7. Turn the keyboard over and lay it on top of the palmrest.



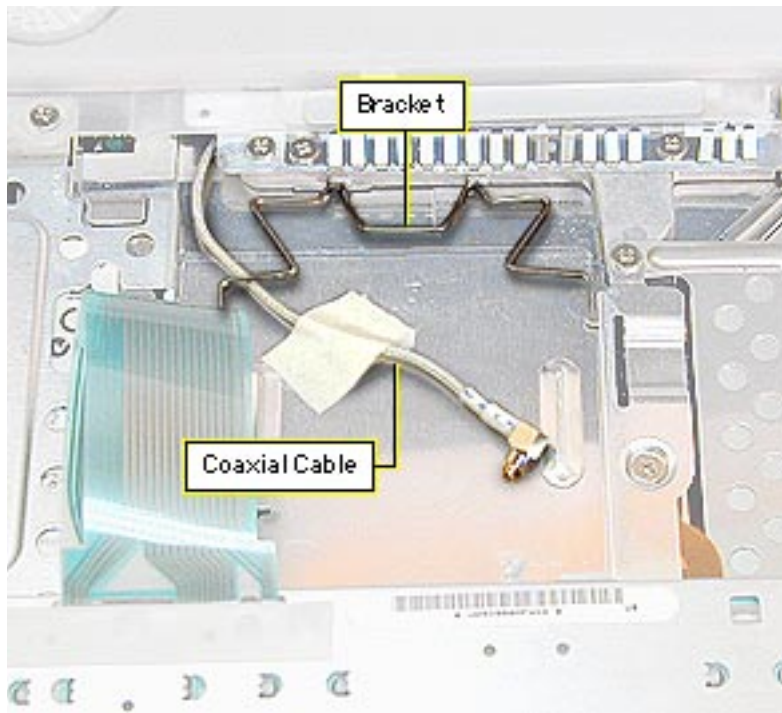

8. Pull the bracket handle toward you to free the top edges from the EMI shield.
9. Remove the tape from the coaxial cable and move the cable to the side.
10. Slide the Airport card into its connector under the top case with the AirPort ID number facing up.





11. Attach the coaxial cable to the AirPort card.

12. Push the bracket down over the coaxial cable and catch the top edges under the EMI shield.

Important: After installing an AirPort Card into a new iBook you must press Option-S when restarting the computer. This ensures the customer will see the Setup Assistant (a movie and setup instructions). If these keys are not pressed down each time the technician restarts the computer after an upgrade, the Setup Assistant file will execute, disable itself, and the customer will never see it.





Memory

The iBook comes with a minimum of 32 MB of memory soldered on the logic board. Newer iBooks and iBook Special Edition have 64 MB soldered on the logic board.

One RAM expansion slot can accommodate a single 1.25-inch SO-DIMM. iBook Special Edition and iBook models with 64 MB on the logic board can support up to a 1.35-inch, 256 MB SO-DIMM.

Important: Use only SO-DIMMs. Other devices may physically fit in the expansion slot, but they are not compatible.





iBook Memory Configurations

iBook Model	RAM on Logic Board	Supported SO-DIMM Sizes	Maximum Supported RAM
Original Release	32 MB	32, 64, 96, or 128 MB	160 MB
Second Release	64 MB	32, 64, 96, 128, or 256 MB	320 MB
Special Edition	64 MB	32, 64, 96, 128, or 256 MB	320 MB





iBook Memory Information	
RAM Speed	66 MHz (15 ns)
RAM Type	144-pin SDRAM
RAM Voltage	3.3 volt, PC 66 compliant
Virtual Memory	1 GB
Soldered Video SDRAM	4 MB
Number of VRAM Slots	none

Note: Use SO-DIMMs only. EDO or SGRAM devices may fit in the slots, but several beeps will be heard at startup.





RAM Installation

Before you begin, remove the following:

- AC adapter
- Battery
- AirPort Card (if present)

1. Remove the two Phillips screws on the right side of the RAM access door.
2. Lift the RAM access door out.
3. If a RAM card is in the slot under the RAM access door, pull the snaps on each side of the RAM connector to the

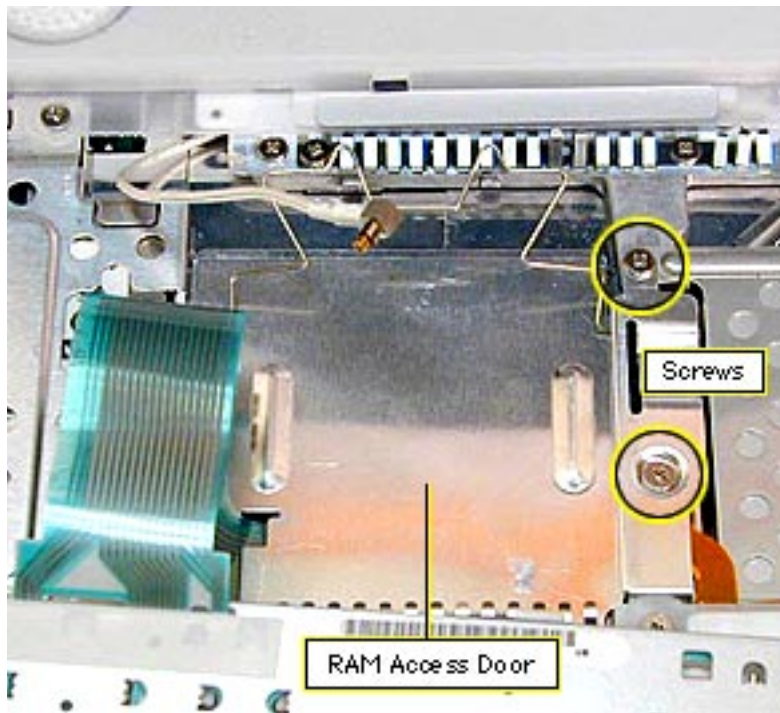



sides until the RAM card pops up.

4. Pull the RAM card straight out to remove it.
5. Position the new RAM card so the notches in the card line up with the notches in the slot, and insert the card into the slot at an angle.
6. When the card is firmly seated in the slot, press down on the card until the snaps lock into place.

Important: After upgrading memory on a new iBook you must press Option-S when restarting the computer. This ensures the customer will see the Setup Assistant (a movie and setup instructions). If these keys are not pressed down each time the technician restarts the computer after an upgrade, the Setup Assistant file will execute, disable itself, and the customer will never see it.





Exploded View

iBook/iBook Special Edition





Introduction

The Exploded View chapter is not available for iBook. Refer to the Basics chapter of the iBook service manual for an overview of the internal hardware design and logic board drawing.

